

**BALTON**

**B III**

**21220/  
21222**

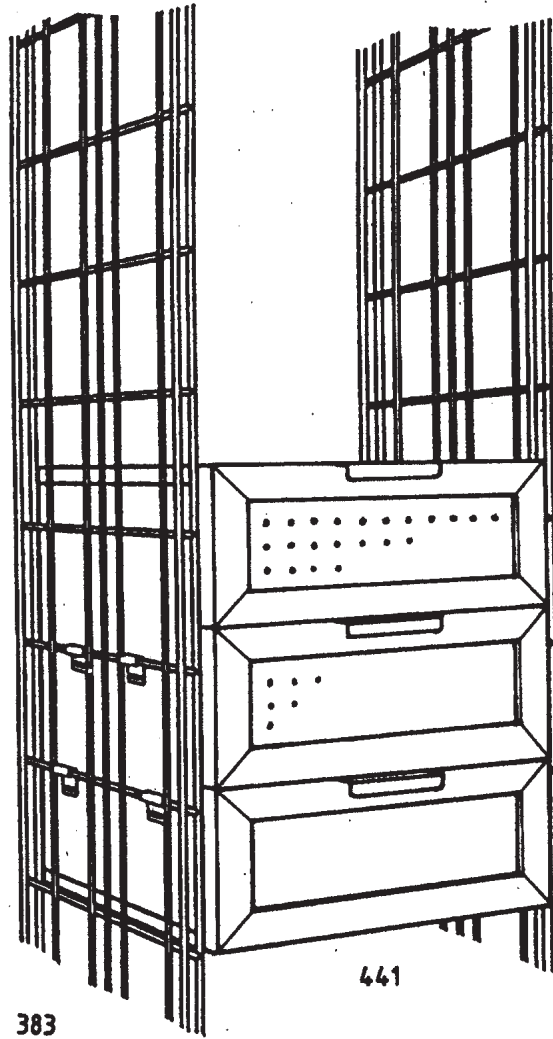

### Monteringsanvisning

#### PRODUKTBEKRIVNING

Lådhyrt i trä med 3 lådor. Tillverkad i Sverige.



### Assembly Instructions

#### DESCRIPTION OF PRODUCT

Wood pedestal unit with 3 drawers.  
Made in Sweden.



### Montageanleitung

#### PRODUKTBEKRIBUNG









Aktenschrank, Holz, mit vier 3-Schubladen.  
Hergestellt in Schweden.

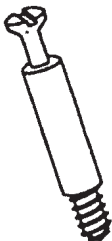

### Instructions de montage

#### DESCRIPTION DU PRODUIT

Caisson à tiroirs en bois avec 3 tiroirs.  
Fabriquée en Suède.

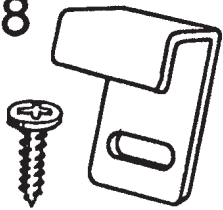
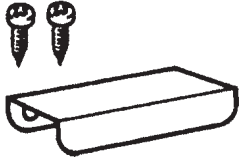
16 	12 	6 	8 	14 
6 	12 	6 	8 	3 

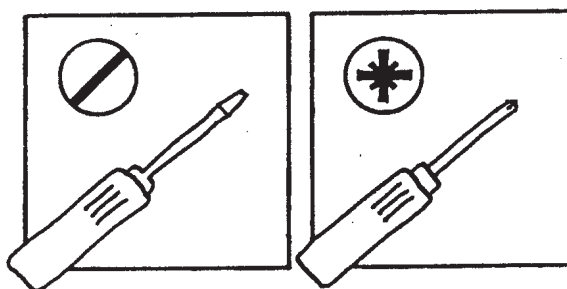

## Före montering

Läs igenom hela anvisningen innan arbetet påbörjas. Kontrollera innehållet i förpackningen. Kontakta försäljningsstället om något är felaktigt eller fattas. Se till att de skuggade verktygen finns tillgängliga. Montera steg för steg enligt anvisningen.



## Vor der Montage

Lesen Sie bitte als erstes die Montageanleitung sorgfältig durch. Überprüfen Sie den Verpackungsinhalt. Falls Teile fehlen oder defekt sind, setzen Sie sich bitte mit Ihrem Fachhändler in Verbindung. Achten Sie darauf, daß die schraffiert dargestellten Werkzeuge bereitliegen. Die Montage erfolgt schrittweise gemäß Anleitung.



## Before assembly

Read through the instructions carefully before starting assembly. Check the contents of the package. Contact the point of sale if you find anything defective or missing. Make sure that the shaded tools are available. Assemble step by step as shown in the instructions.



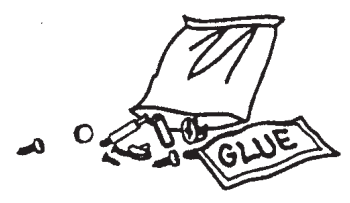
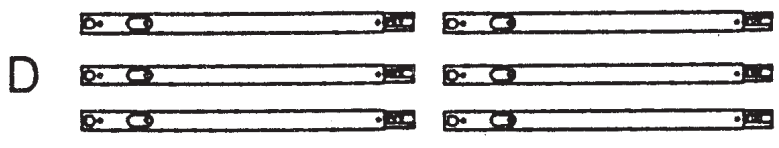
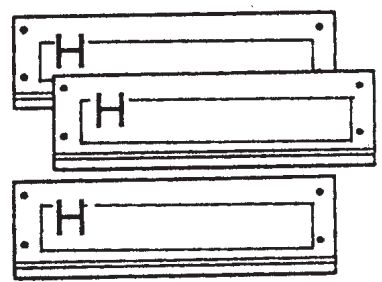
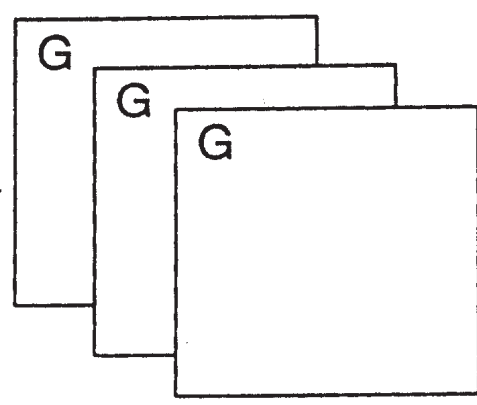
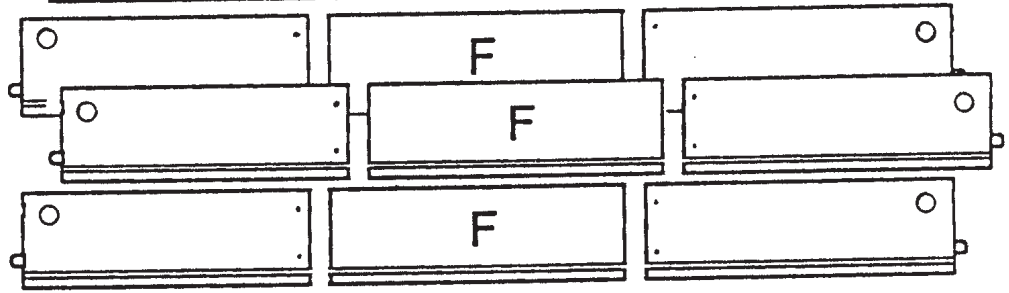
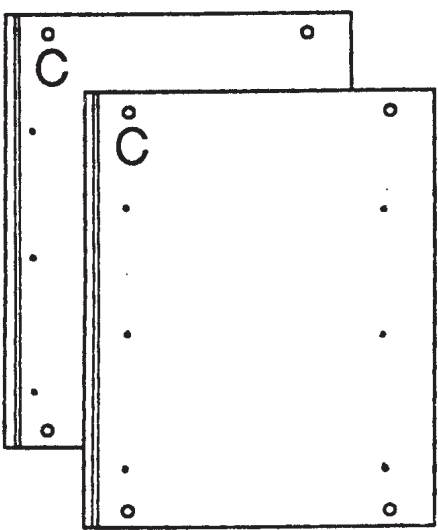
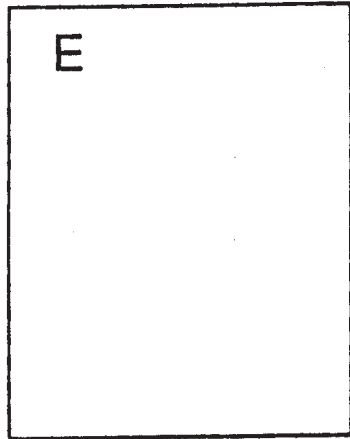
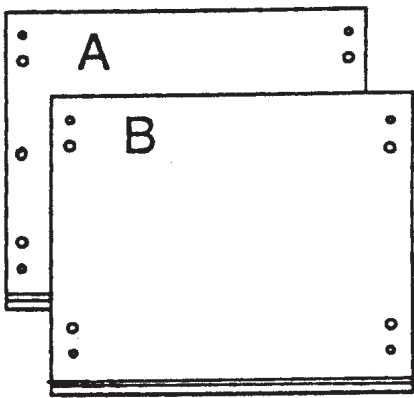

## Avant le montage

Lisez attentivement les instructions avant de commencer les travaux de montage. Contrôlez le contenu de l'emballage. En cas de pièces endommagées ou manquantes, contactez le point de vente. Assurez-vous que les outils nécessaires sont disponibles. Effectuez le montage étape par étape suivant les instructions.



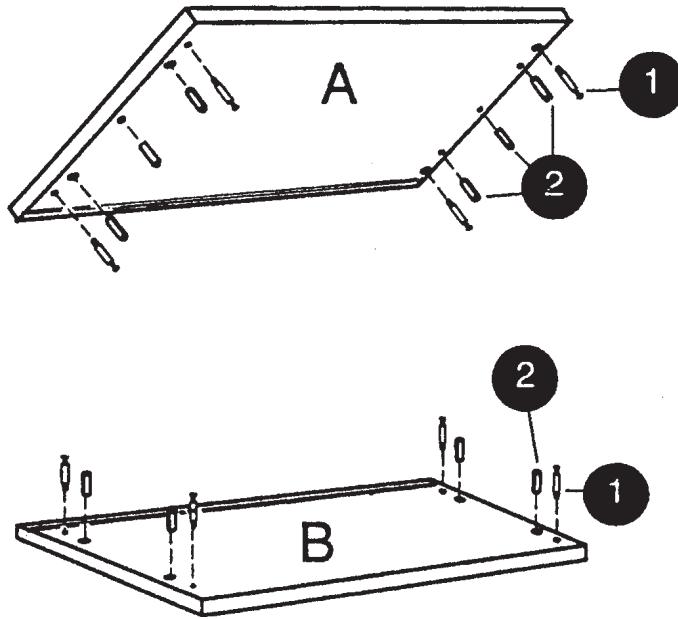

# a

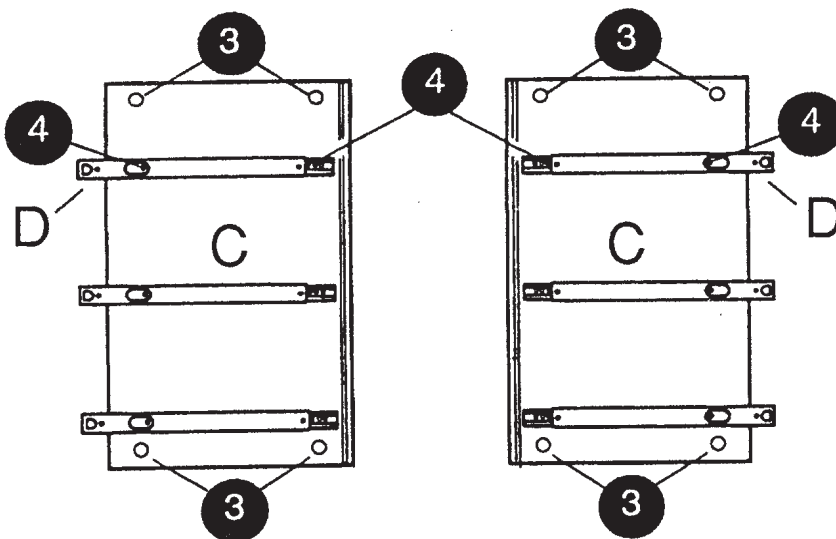

	
1 X8	
2	X10

# b



	
3 X8	
4	X12

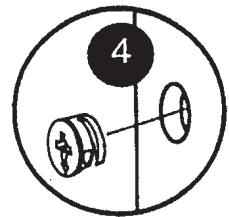

# c

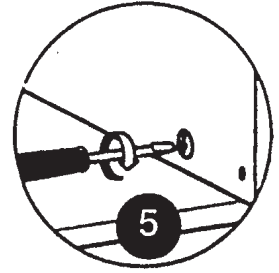
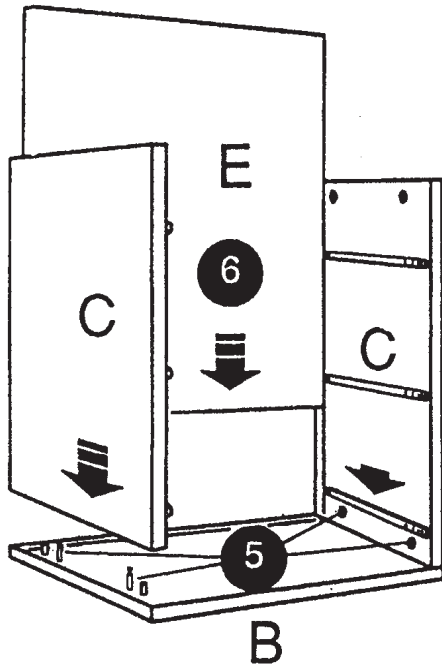

# d

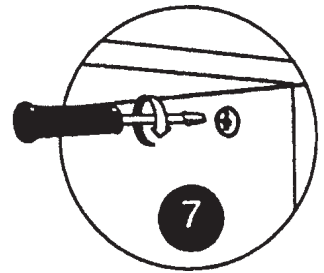
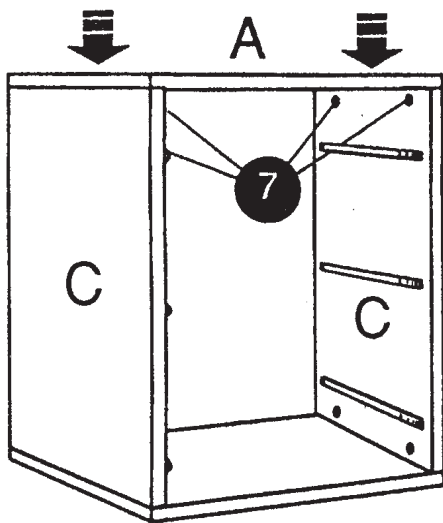



8	X6						
9		X6					
10			X6				
11				X6			
12					X12		
13						X3	
14							X6

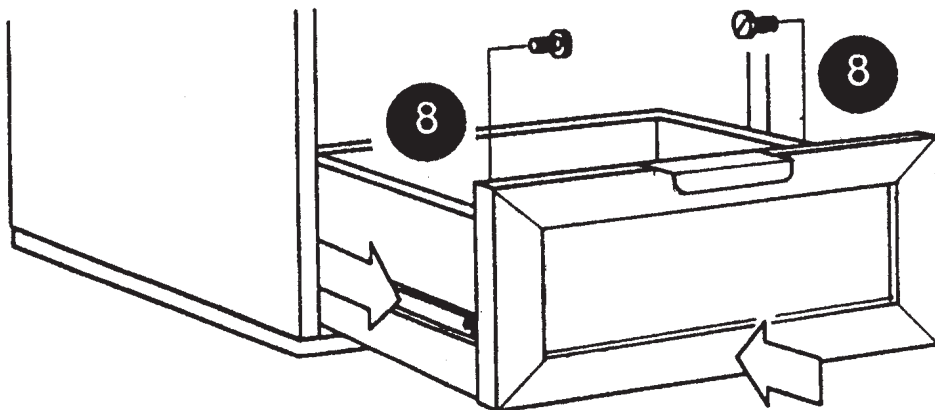
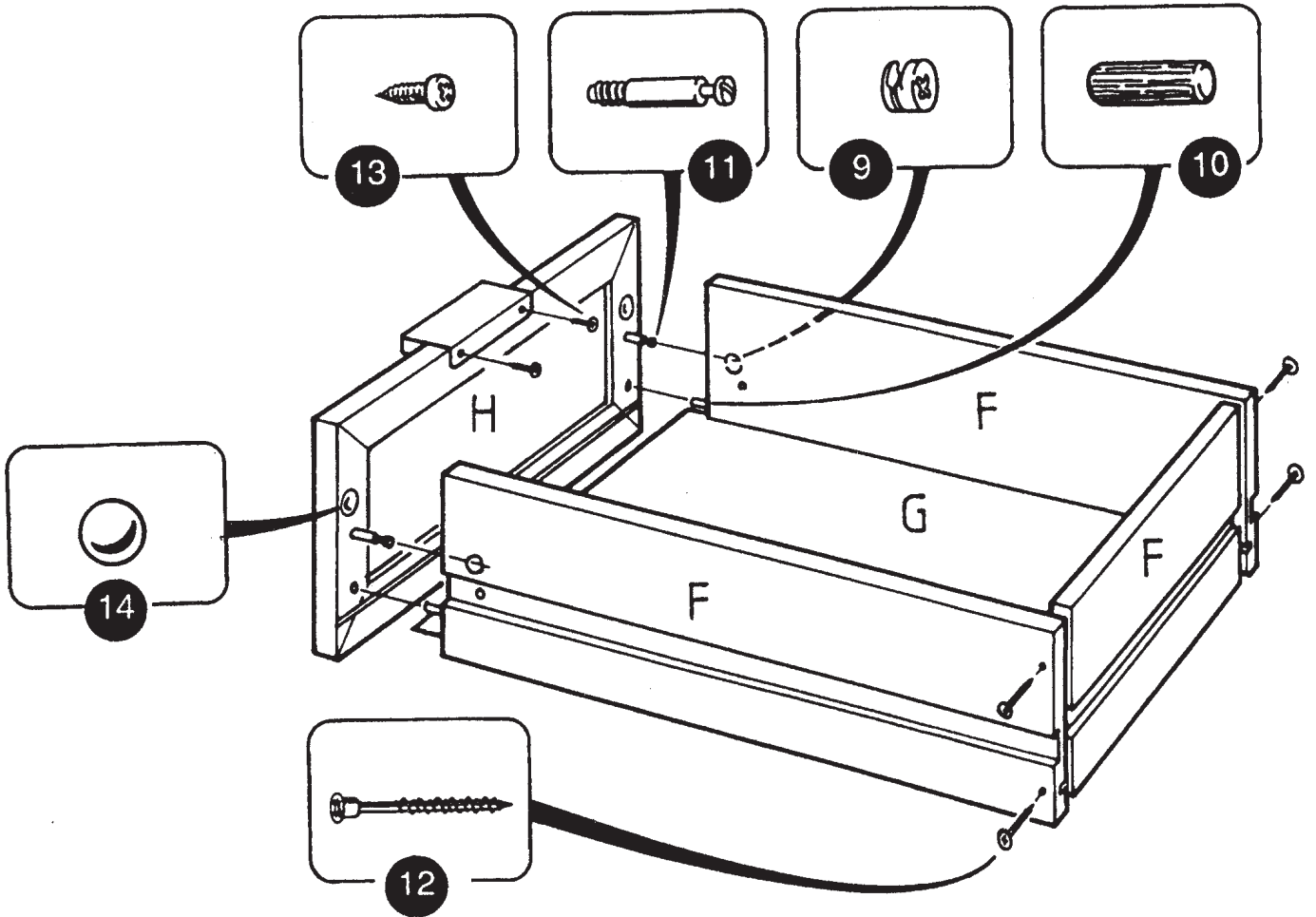

f

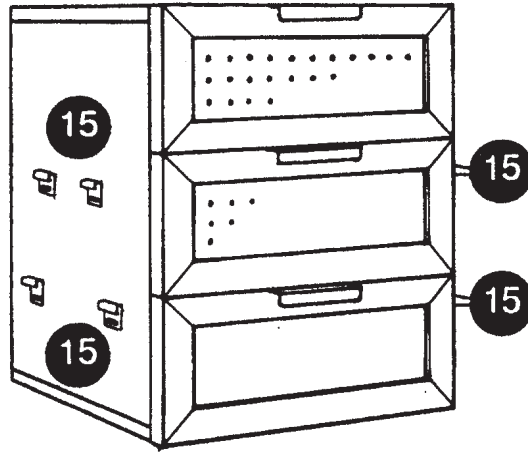
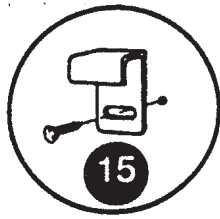
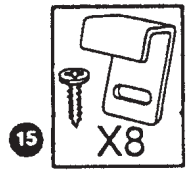

g

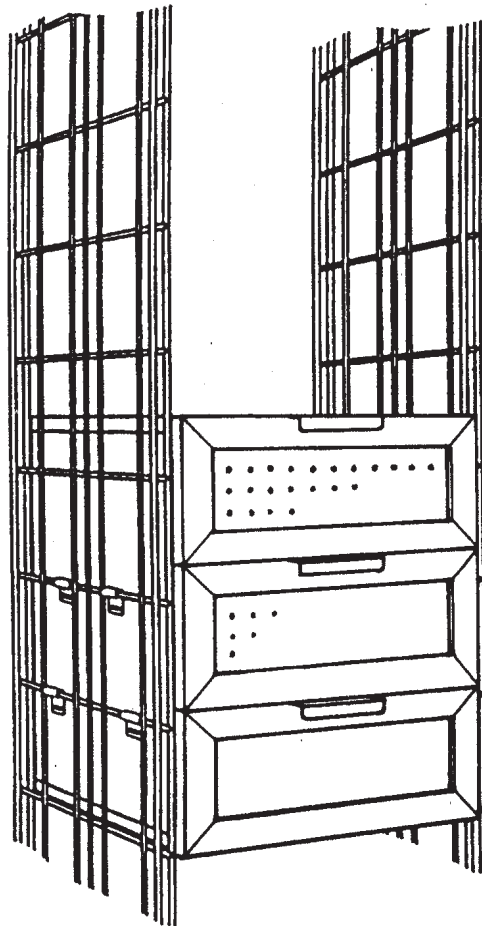

# B III

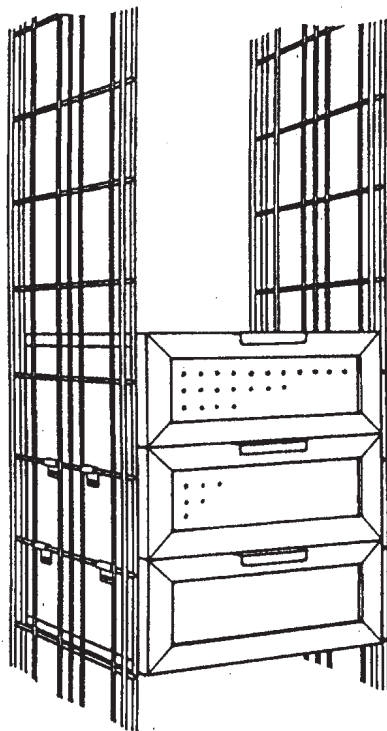

**21220/21222**

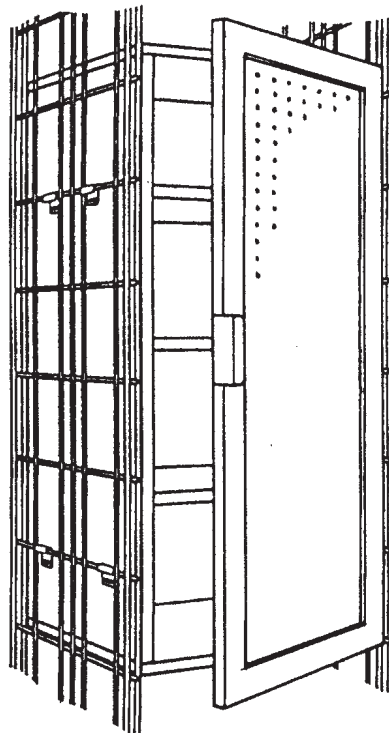

**21322/21422**



## Några goda råd

Efter någon vecka bör skruvar och bultar kontrolleras och dragas åt på nytt. Vid rengöring rekommenderar endast vatten och mild tvällösning. Eftertorka med mjuk torr trasa. Andra rengöringsmetoder kan orsaka skador som ej omfattas av garantin.



## Noch einige gute Tips

Nach ungefähr einer Woche sollten die Schrauben und Bolzen überprüft und nachgezogen werden. Die Reinigung erfolgt nur mit Wasser und milder Seifenlauge, anschließend mit einem weichem Lappen trockenreiben. Andere Reinigungsmethoden bzw. -mittel können Schäden verursachen, für die der Hersteller nicht haftet.



## Some useful advice

You should check and re-tighten the screws and bolts a few weeks after assembly. For cleaning, use mild soapy water only and dry with a soft cloth. Other cleaning agents may cause damage not covered by the warranty.



## Quelques bons conseils

Après quelques semaines, il convient de contrôler et de serrer à nouveau les vises et les boulons. Pour le nettoyage, utilisez de l'eau savonneuse douce. Essuyez avec un chiffon doux. D'autres méthodes de nettoyage peuvent causer des dommages non-couverts par la garantie.

**BALTON**